

**KONAMI**®

2 or 4 Player  
Dip Switch  
Adjustable

# METAMORPHIC FORCE™

© 1993 KONAMI  
ALL RIGHTS RESERVED.

KONAMI METAMORPHIC FORCE™ is a trademark of KONAMI (America) Inc.  
1993 KONAMI (America) Inc. All rights reserved.

© Konami Inc. 1993 Konami® is a trademark of Konami Co., Ltd.

Service & Parts #

**708-215-5100**

Jerry Korbecki Ext. 122  
George Limonez Ext. 123

# INSTRUCTION MANUAL

**KONAMI**® (America) Inc. is a trademark of Konami Industry Co., Ltd.

# **METAMORPHICFORCE PARTS LIST**

---

<b>Part #</b>	<b>Description</b>
224003	PCB
224100	Control Panel Overlay
224101	Player Instructions
224200	Marquee
224300	Upper Side Decal
224301	Lower Side Decal
224400	Manual
30255	Red Buttons
30256	Yellow Buttons
30258	Blue Buttons
30259	Green Buttons
30261	Micro Switches
30262	Palnuts
30335	Joysticks
40901	Speaker Harness
40906	3 & 4 Player Harness

# METAMORPHIC FORCE WIRING HARNESS

\*JAMMA HARNESS NOT SUPPLIED

Solder Side ← → Parts Side

GND	A	1	GND
GND	B	2	GND
+5V DC	C	3	+5V DC
+5V DC	D	4	+5V DC
NOT USED	E	5	NOT USED
+12V DC	F	6	+12V DC
*KEY	H	7	*KEY
(EMPTY)	J	8	COIN COUNTER
(EMPTY)	K	9	(EMPTY)
SPEAKER (-)	L	10	SPEAKER (+)
(EMPTY)	M	11	(EMPTY)
VIDEO GREEN	N	12	VIDEO RED
VIDEO SYNC	P	13	VIDEO BLUE
(EMPTY)	R	14	VIDEO GROUND
(EMPTY)	S	15	TEST SWITCH
COIN 2	T	16	COIN 1
*2P START	U	17	1P START*
2P UP	V	18	1P UP
2P DOWN	W	19	1P DOWN
2P LEFT	X	20	1P LEFT
2P RIGHT	Y	21	1P RIGHT
2P ATTACK	Z	22	1P ATTACK
2P JUMP	a	23	1P JUMP
NOT USED	b	24	NOT USED
NOT USED	c	25	NOT USED
NOT USED	d	26	NOT USED
GND	e	27	GND
GND	f	28	GND

(BASE COLOR/LINE COLOR)

\*Start buttons are not used with 4 player 4 coin slot setting. See page 5.

# **METAMORPHIC FORCE SUB HARNESS (For 3 Players & 4 Players)**

<b>CN3 3P CONTROLS</b>	1	Coin 3
	2	Empty
	3	3P Left
	4	3P Right
	5	3P Up
	6	3P Down
	7	3P Attack
	8	3P Jump
	9	Not Used
	10	3P Start*
	11	Empty
	12	Empty
	13	Empty
	14	Ground
	15	Ground

<b>CN4 4P CONTROLS</b>	1	Coin 4
	2	Empty
	3	4P Left
	4	4P Right
	5	4P Up
	6	4P Down
	7	4P Attack
	8	4P Jump
	9	Not Used
	10	4P Start
	11	Empty
	12	Empty
	13	Empty
	14	Ground
	15	Ground

\*Start buttons are not used with 4 player 4 coin slot setting.

# METAMORPHIC FORCE TECHNICAL INFORMATION

---

---

## TECHNICAL INFORMATION

---

- (1) Required power capacity  
GND-Vcc 5V 4A or more  
GND-(+12V)  
\*See the Wiring Diagram.
  - (2) Output  
R (red) analog, positive  
G (green) analog, positive  
B (blue) analog, positive  
SYNC. H-V complexed, negative
  - (3) The monitor should be installed horizontally.
  - (4) There is no sound volume knob on the PCB. Sound level should be adjusted in the Manual Test mode. (See page 5.)
  - (5) Handle with care.
- 

## PLAYING INSTRUCTION

---

- This game can be adjusted for both 2 Player or 4 Player simultaneous play mode. Choose which mode you would like with the DIP Switch, when installed on site. (See page 8 on DIP Switch setting.)
  - In 2 Player mode select the character you want to control on the screen. In 4 Player mode the control panel against the cabinet dictates the character you will control.
  - Player(s) can join in at any time. You can continue to play by depositing additional coin(s) when the game is over.
  - The character's energy is decreased when damaged by enemy's attack. When the energy points reach 0, the game is over. The quantity of energy you will get by depositing 1 coin can be adjusted in the GAME OPTION. You can also collect bonus points as well as more energy when depositing coin(s).
  - By getting item(s) that appear during the game, you obtain a special bonus, like regaining energy, etc.
  - The biggest feature of this game is the metamorphoses of characters into Beasts by getting Statues. At this point they can become the strongest Golden Beast by getting additional Statues.
  - When characters change into Beasts there appears a "Beast Energy Meter." When this meter reaches the bottom the character dies, unless you deposit additional coin(s) to continue to play (this makes your character human again).
- 

## HOW TO CONTROL

---

- Control your character's movements by using the 8-way Joystick.
- Attack enemies with BUTTON 1. Combination of movement and/or timing of Joystick and BUTTON 1 makes the character attack in special ways.
- Press BUTTON 2 to make your character JUMP. Pressing both buttons enables character to make special attacks.

# METAMORPHICFORCE TECHNICAL INFORMATION (cont.)

## CONTROL PANEL INFORMATION

- Use control panel with sufficient sets (2 or 4) of an 8-way Joystick and 2 buttons for each player. If the setting is COMMON coin slot mode, SHOT button can be used as START button.

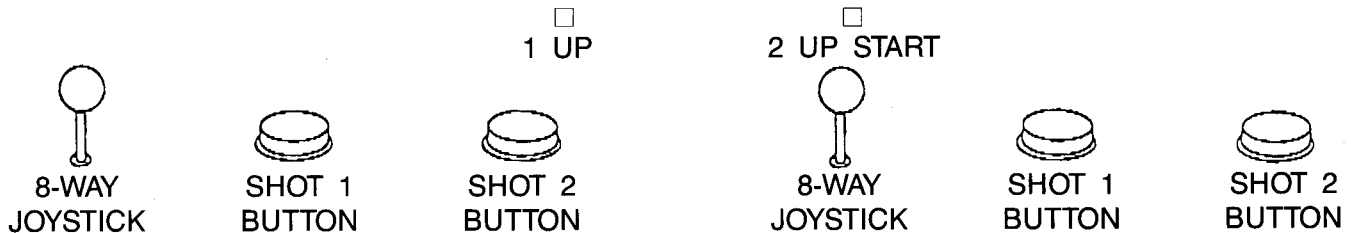

## SELF TEST

Normal: "OK" will be displayed. Then the game will start.

Abnormal: "BAD" will be displayed and self test will repeat. If "VERSION ERROR" is displayed, switch off and switch on again while continually pressing down on the TEST SWITCH on the PCB. Switching on with TEST SWITCH pressed causes the settings of the manual test to be initialized to default.

## MANUAL TEST

### (1) HOW TO START

After switching on the power, press the TEST SWITCH on the PCB or on the cabinet, and you will get the MAIN MENU of the Manual Test.

NOTE: Switching on with TEST SWITCH pressed causes the program in the EEPROM to be initialized to default.

### (2) HOW TO RETURN TO THE GAME MODE

Select "GAME MODE" on the MAIN MENU then press Player 1 SHOT 1 button to return to the game mode.

### (3) ITEMS AND HOW TO SELECT

Use player 1 JOYSTICK to move arrow to desired test and press player 1 SHOT button to initiate testing. Press player 1 SHOT button during or at the end of each test to return to the MAIN MENU.

MAIN MENU
I/O CHECK
SCREEN CHECK
COLOR CHECK
MASK ROM CHECK
GAME OPTIONS
COIN OPTIONS
SOUND OPTIONS
DIP SWITCH OPTIONS
GAME MODE
PLAYER 1 JOYSTICK=SELECT ITEM
PLAYER 1 SHOT=DO CHECK

...Return to GAME MODE

# METAMORPHIC FORCE TECHNICAL INFORMATION (cont.)

## (4) EXPLANATION OF THE ITEMS

The following screen below will appear. Select item to be modified with Player 1 JOYSTICK up/down and move JOYSTICK right/left to modify setting. Factory settings are shown in green, and modified results in red. After modification is completed, select "SAVE AND EXIT" and press Player 1 START button to save and return to MAIN MENU.

\* If you select "EXIT" instead of "SAVE AND EXIT" after modifying some settings, the message appears; "YOU DID NOT SAVE. DO YOU WANT TO SAVE? YES/NO." When you choose "YES," the screen shows "NOW SAVING" and returns to MAIN MENU. If you select "NO," "NO MODIFICATION" is shown and then MAIN MENU appears.

### 1. I/O CHECK

Check the JOYSTICK and all buttons to see "1" when switched on. Press Player 1 and 2 SHOT buttons at the same time to return to MAIN MENU.

### 2. SCREEN CHECK

Adjust focus, alignment, size, etc. using the cross-hatch screen.

### 3. COLOR CHECK

Adjust color brightness so that the specified area will be colorless.

### 4. MASK ROM CHECK

Roms will be checked one after another, and the message "OK" or "BAD" will be displayed on the screen.

### 5. GAME OPTIONS

The following screen below will appear.

GAME OPTIONS		
PLAYER'S ENERGY LEVEL	100	... Player's energy level for 1 coin (50 to 400)
DIFFICULTY LEVEL	4/MEDIUM	... Select out of 8 levels
VIDEO SCREEN FLIP	NORMAL	... "NORMAL" or "UPSIDE DOWN"
LOOP SETTING	GAME OVER AFTER SECOND ROUND	... "GAME OVER AFTER FINAL STAGE" "GAME OVER AFTER SECOND ROUND" or "ENDLESS"
FACTORY SETTINGS		... Returned to factory settings
SAVE AND EXIT		
EXIT		
PLYR 1 JOYSTICK UP/DOWN=SELECT OPTION JOYSTICK RIGHT/LEFT=MODIFY SETTING		

(Settings above are not always the factory settings.)

# METAMORPHICFORCE TECHNICAL INFORMATION (cont.)

## (6) COIN OPTIONS

When you select this item, the following screen will appear. The specifications are for COMMON coin slot (DIP SW2 off) and for INDEPENDENT coin slot (DIP SW2 on).

### (INDEPENDENT)

COIN OPTIONS	
COIN MECHANISM	INDEPENDENT
PREMIUM START	NO
STARTING	1 COIN 1 CREDIT
CONTINUATION	1 COIN 1 CREDIT
FACTORY SETTINGS	
SAVE AND EXIT	
EXIT	
PLYR 1 JOYSTICK UP/DOWN=SELECT OPTION	
JOYSTICK RIGHT/LEFT=MODIFY SETTING	

...Indication for INDEPENDENT setting.  
Modified with DIP Switch.  
...Set for PREMIUM START. "NO" or "YES 1" to "YES 4."  
...Set the number of credit for Start and Continue (1-8).

} Same as above "GAME OPTION"

### (COMMON)

COIN OPTIONS	
FREE PLAY	NO
COIN MECHANISM	COMMON
COIN SLOT 1	1 COIN 1 CREDIT
COIN SLOT 2	1 COIN 1 CREDIT
FACTORY SETTINGS	
SAVE AND EXIT	
EXIT	
PLYR 1 JOYSTICK UP/DOWN=SELECT OPTION	
JOYSTICK RIGHT/LEFT=MODIFY SETTING	

...Set for Free Play. "YES" or "NO"  
...Indication for COMMON setting.  
Modified with DIP Switch.  
...Set the number of credit for Start and Continue (1-8).

} Same as above "GAME OPTION"

### \*COIN SETTING OPTIONS

COIN(S)	1	1	1	1	1	1	1	2	2	2	3	3	3	4	4	4
CREDIT(S)	1	2	3	4	5	6	7	1	3	5	1	2	4	1	3	5



# METAMORPHICFORCE TECHNICAL INFORMATION (cont.)

## (7) SOUND OPTIONS

The following screen below will appear.

SOUND OPTION

SOUND IN ATTRACT MODE ALL THE TIME

SOUND SCALE CHECK

SOUND VOLUME=25

FACTORY SETTING

SAVE AND EXIT

EXIT

PLYR 1 JOYSTICK UP/DOWN=SELECT OPTION

JOYSTICK RIGHT/LEFT=MODIFY SETTING

- ... Select out of the following 4 types  
 "ALL THE TIME," "ONCE EVERY 3 CYCLES,"  
 "ONCE EVERY 5 CYCLES," "COMPLETELY OFF"
- ... "Do re mi...do" will sound
- ... Sound Volume adjustment (0-29)
- ... Returned to Factory Settings

(Settings above are not always the factory settings.)

## (8) DIP SWITCH SETTING

You can check the settings of DIP SWITCH at this item. You can change the settings with DIP SWITCH as per the following:

DIP SWITCH	CONTENTS	DIP SW/ON	DIP SW/OFF
SW1	SOUND OUTPUT	STEREO	MONAURAL
SW2	COIN SLOT SET	INDEPENDENT	COMMON
SW3	NUMBER OF PLAYERS	4P	2P
SW4	ADD COIN(s) DURING PLAY	POSSIBLE	IMPOSSIBLE

# METAMORPHICFORCE PCB LAYOUT

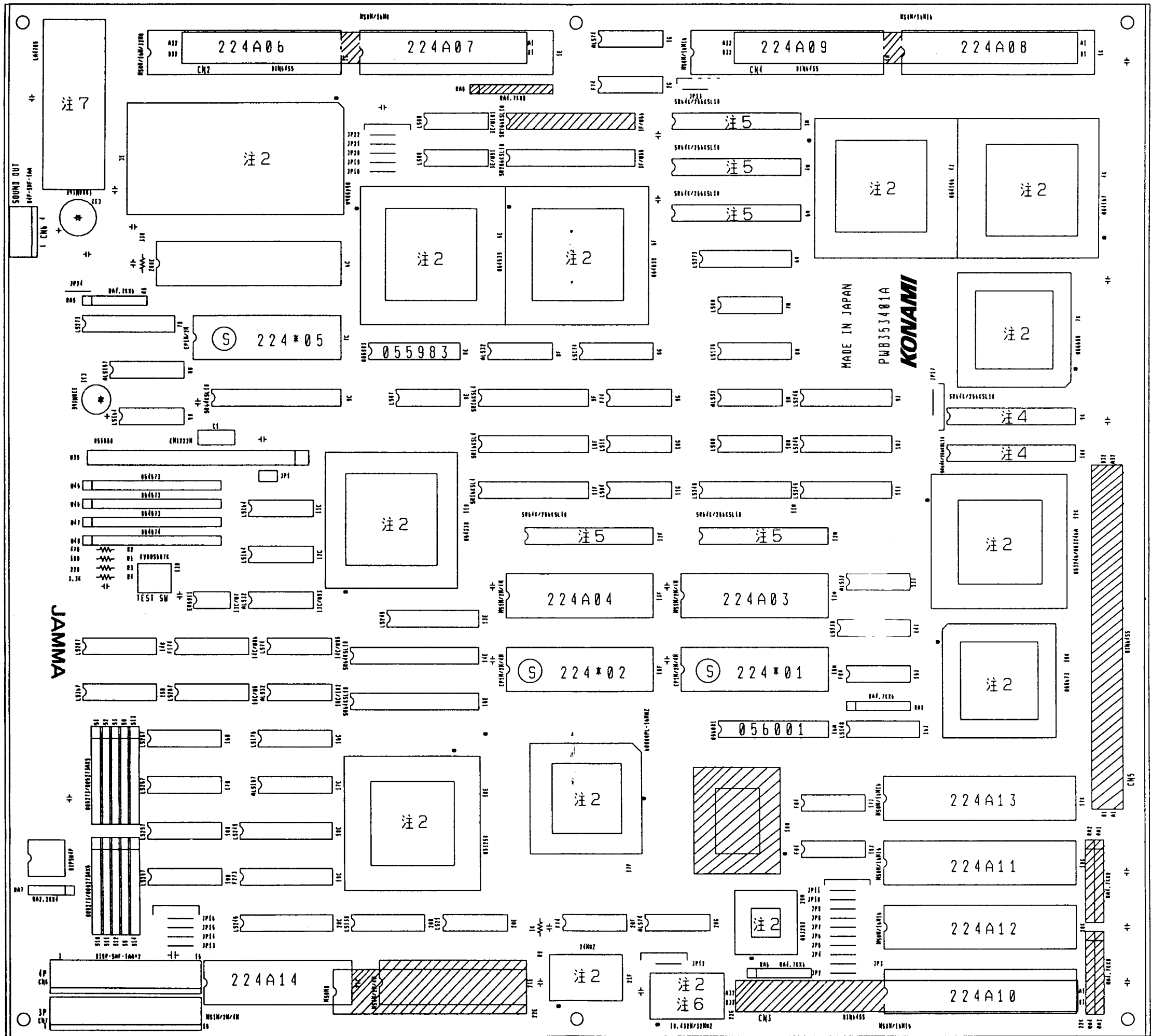



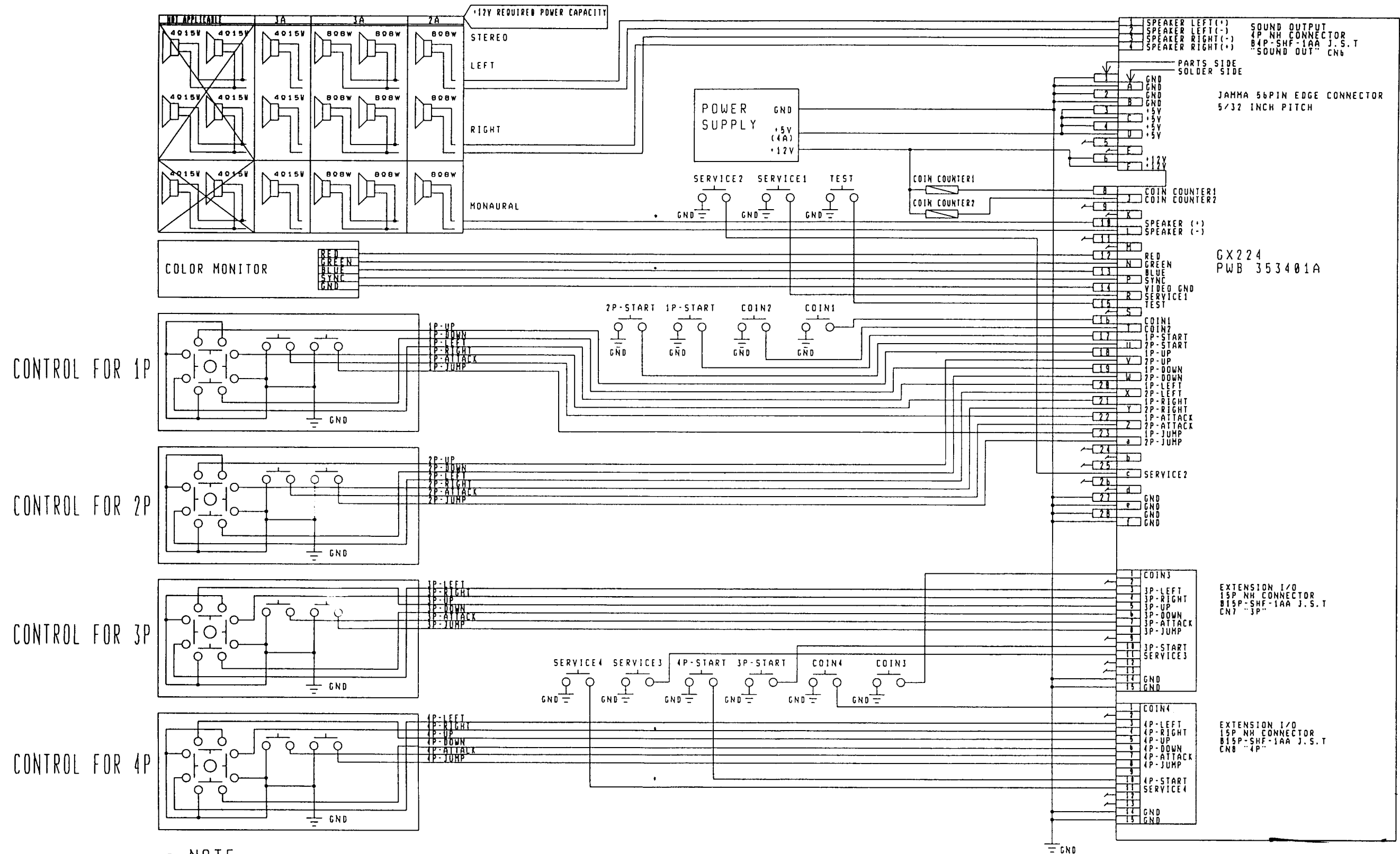

# METAMORPHIC FORCE WIRING DIAGRAM

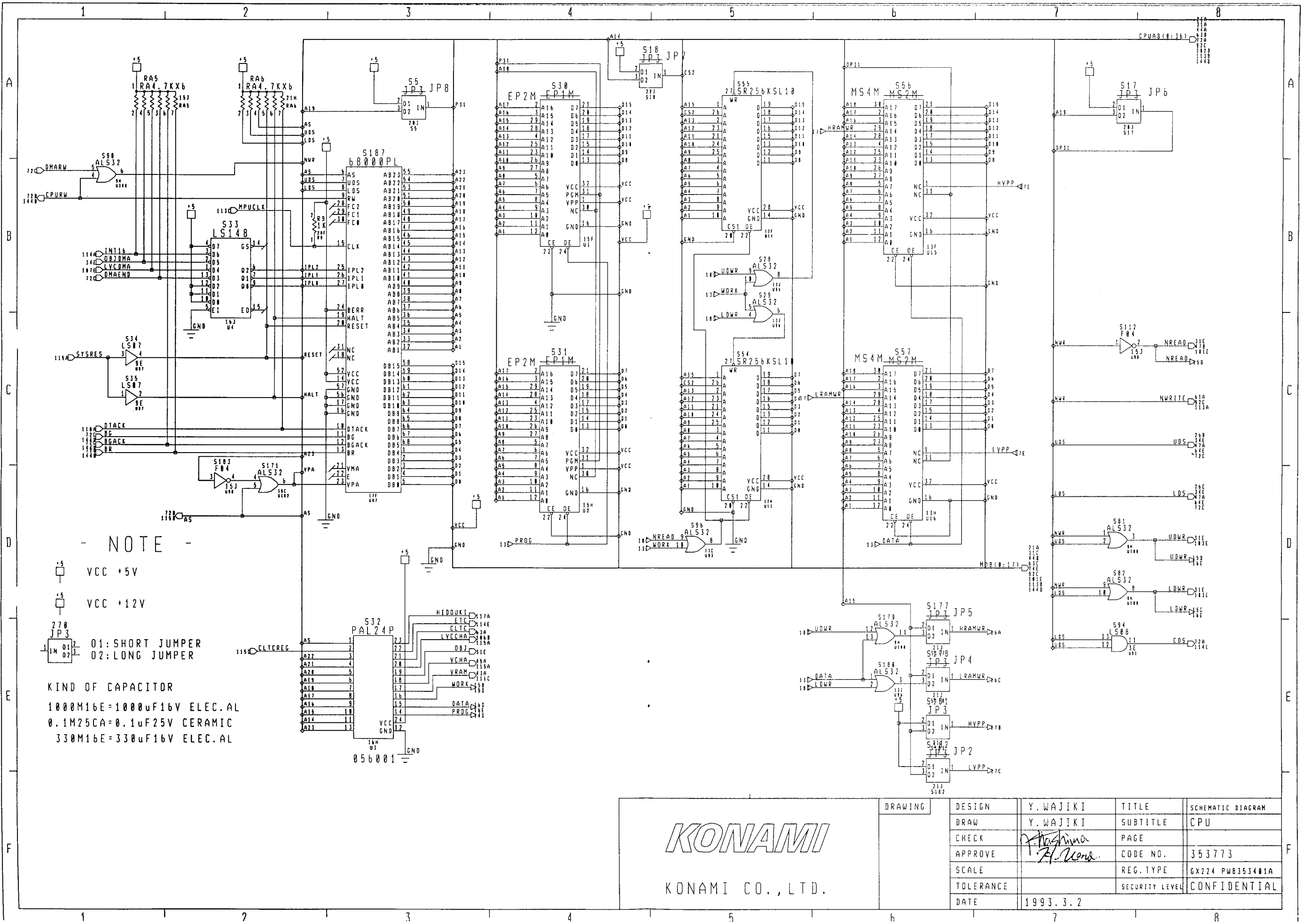

- NOTE -
- (1) 1P:NO.1 PLAYER 2P:NO.2 PLAYER  
3P:NO.3 PLAYER 4P:NO.4 PLAYER
  - (2) SURGE KILLER DIODES FOR COIN COUNTER  
INSTALLED ON THE PCB.
  - (3) YOU CANNOT USE BOTH STEREO AND MONAURAL  
OUTPUTS AT THE SAME TIME.
  - (4) DO NOT CONNECT SPEAKER(-) TO GND.  
SPEAKER(-)



- NOTE -

-  VCC +5V
-  VCC +12V
-  01: SHORT JUMPER
-  02: LONG JUMPER

KIND OF CAPACITOR  
 1000M16E=1000uF16V ELEC.AL  
 0.1M25CA=0.1uF25V CERAMIC  
 330M16E=330uF16V ELEC.AL

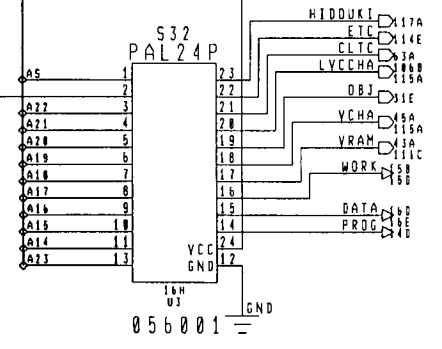

**KONAMI**  
 KONAMI CO., LTD.

DRAWING	DESIGN	Y. WAJIKI	TITLE	SCHEMATIC DIAGRAM
	DRAW	Y. WAJIKI	SUBTITLE	CPU
	CHECK	<i>A. Ashimura</i>	PAGE	
	APPROVE	<i>A. Ueda</i>	CODE NO.	353773
	SCALE		REG. TYPE	GX224 PWB353401A
	TOLERANCE		SECURITY LEVEL	CONFIDENTIAL
	DATE	1993. 3. 2		

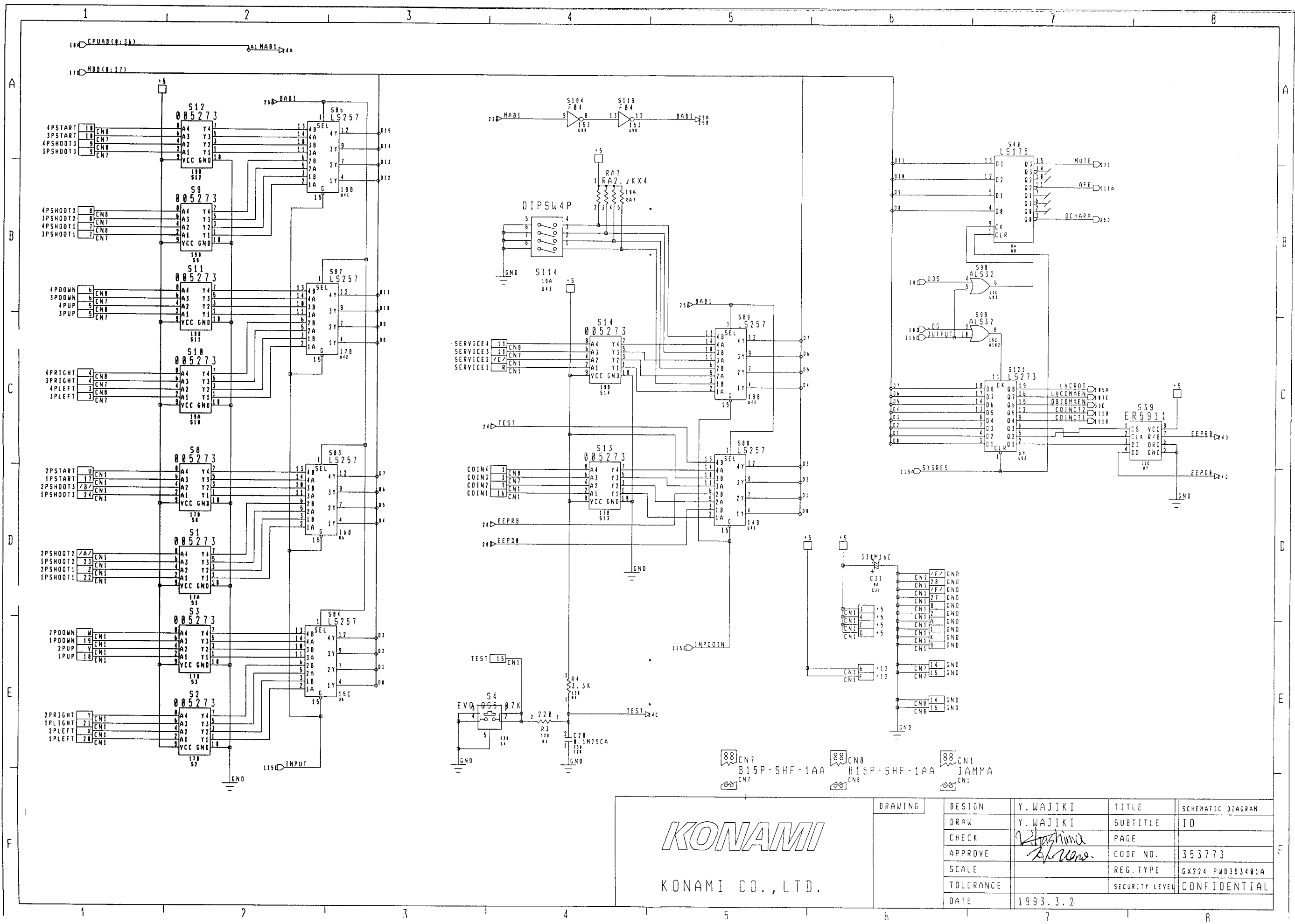

**KONAMI**

KONAMI CO., LTD.

DRAWING	DESIGN	Y. WAJIKI	TITLE	SCHEMATIC DIAGRAM
	DRAW	Y. WAJIKI	SUBTITLE	ID
	CHECK	<i>Hashima</i>	PAGE	
	APPROVE	<i>A. Wano.</i>	CODE NO.	353773
	SCALE		REG. TYPE	GX224 PWB353401A
	TOLERANCE		SECURITY LEVEL	CONFIDENTIAL
	DATE	1993.3.2		

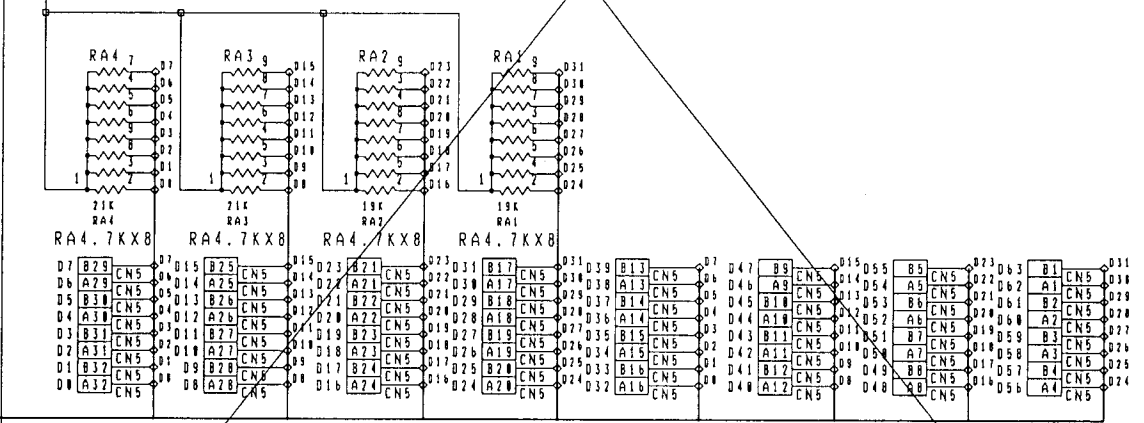
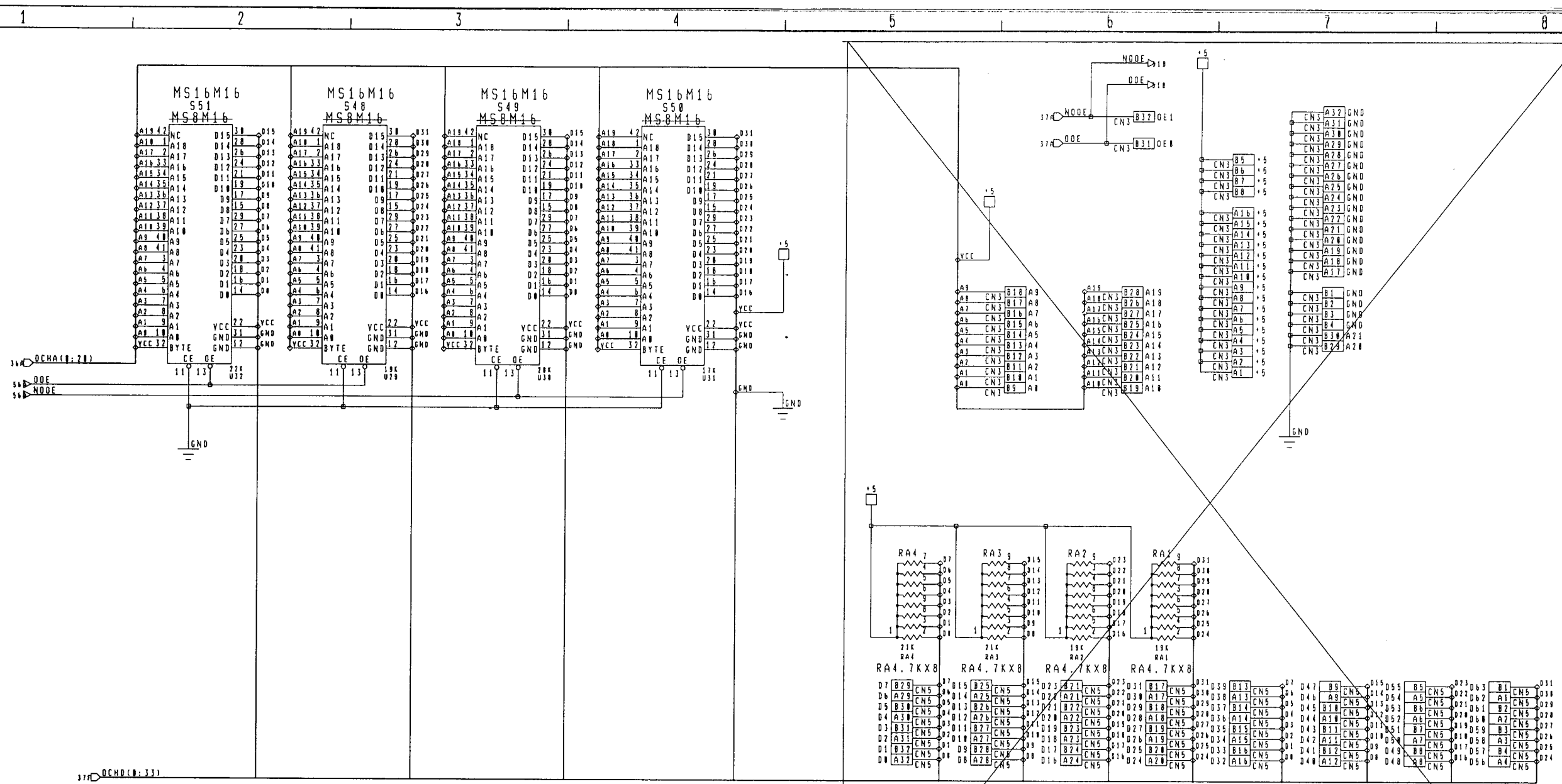

88 CN3 DIN64SS  
 89 CN5

NOT LAYOUT

**KONAMI**  
 KONAMI CO., LTD.

DRAWING	DESIGN	Y. WAJIKI	TITLE	SCHEMATIC DIAGRAM
	DRAW	Y. WAJIKI	SUBTITLE	OBJ CHA
	CHECK	<i>Y. Wajiki</i>	PAGE	
	APPROVE	<i>R. Wano</i>	CODE NO.	353773
	SCALE		REG. TYPE	GX224 PWB353481A
	TOLERANCE		SECURITY LEVEL	CONFIDENTIAL
	DATE	1993. 3. 2		

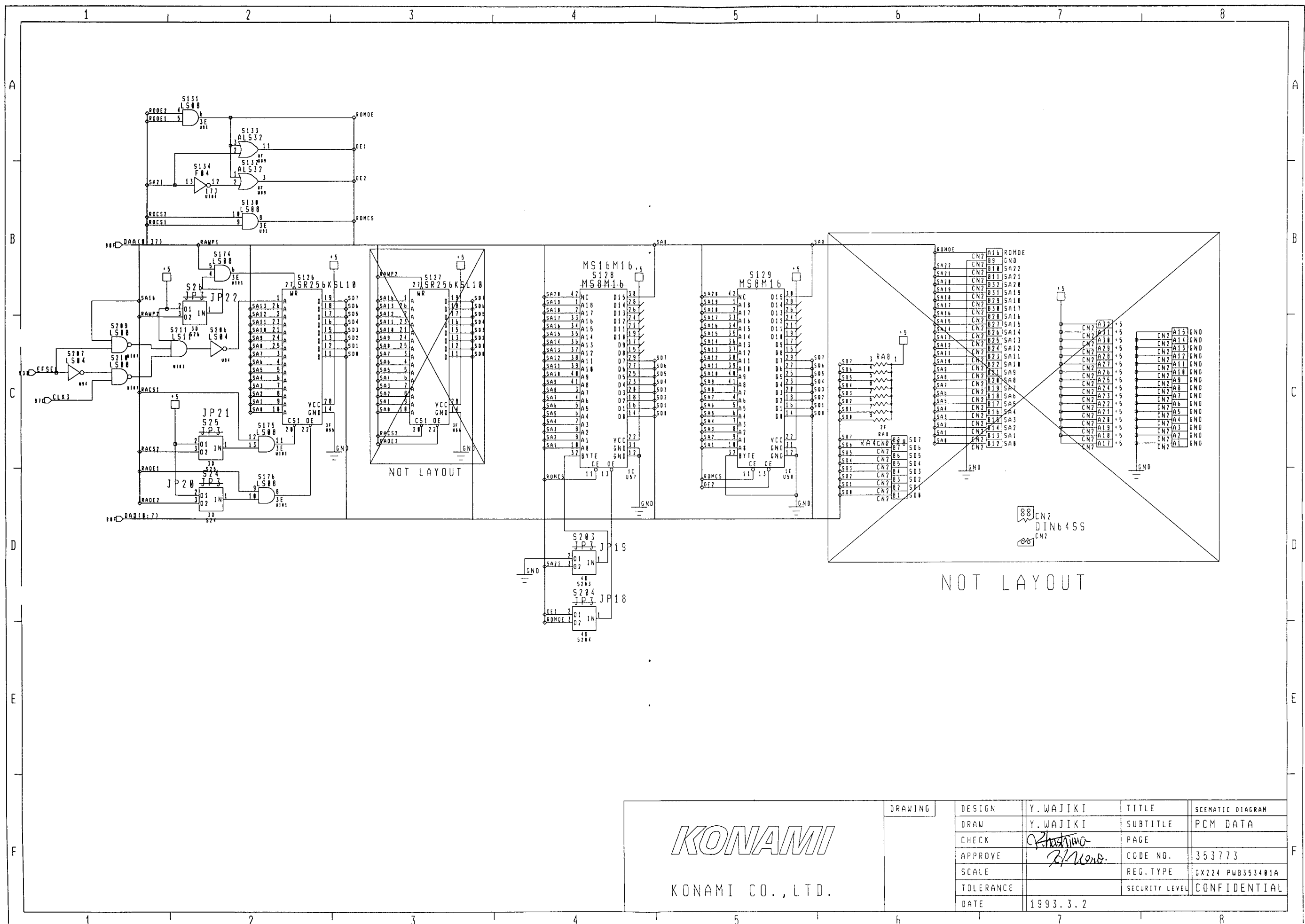

 KONAMI CO., LTD.	DRAWING	DESIGN	Y. WAJIKI	TITLE	SCHEMATIC DIAGRAM
		DRAW	Y. WAJIKI	SUBTITLE	PCM DATA
		CHECK	<i>R. Hoshino</i>	PAGE	
		APPROVE	<i>R. Hoshino</i>	CODE NO.	353773
		SCALE		REG. TYPE	GX224 PWB353401A
		TOLERANCE		SECURITY LEVEL	CONFIDENTIAL
	DATE	1993.3.2			

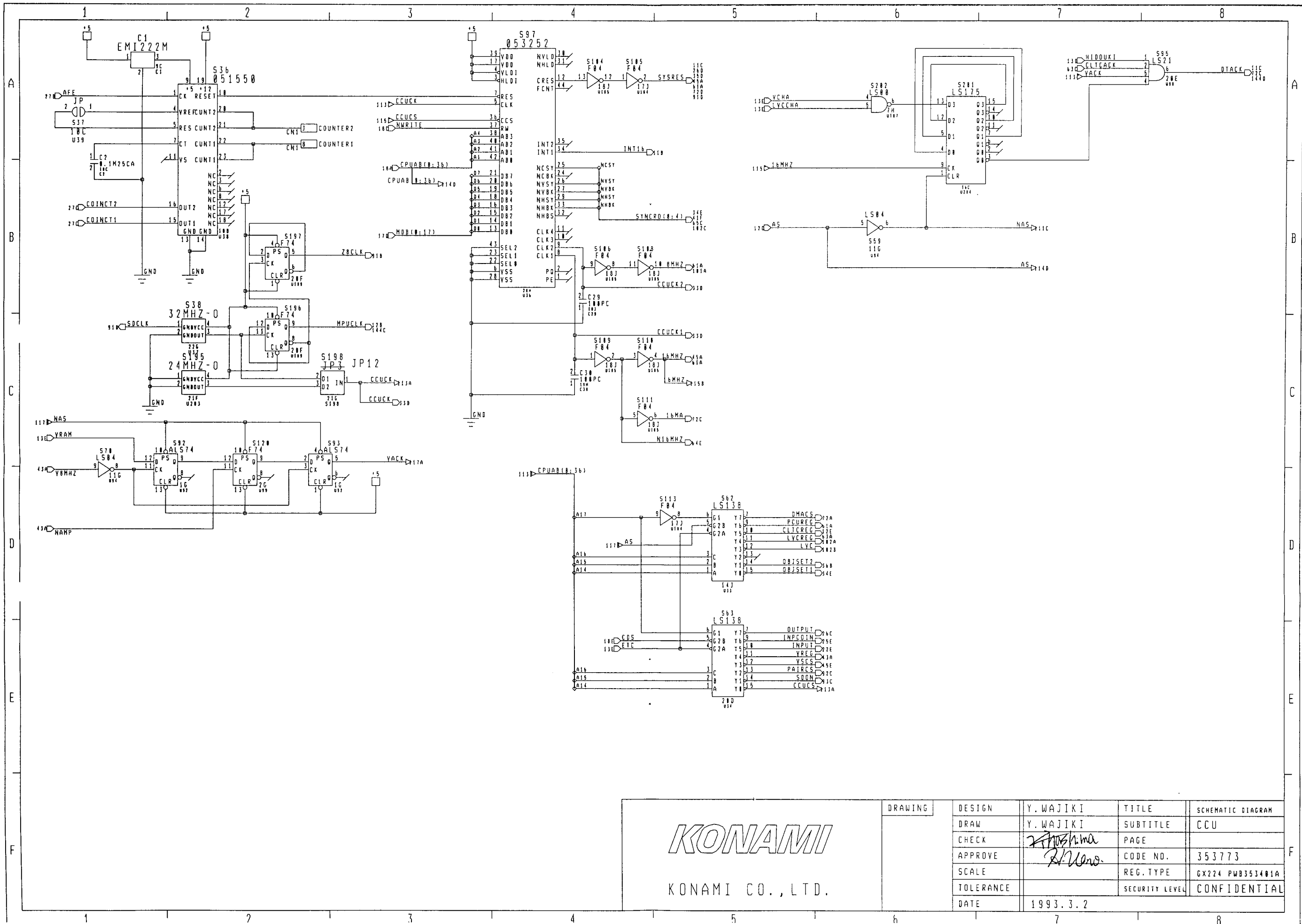

**KONAMI**  
KONAMI CO., LTD.

DRAWING	DESIGN	Y. WAJIKI	TITLE	SCHEMATIC DIAGRAM
	DRAW	Y. WAJIKI	SUBTITLE	CCU
	CHECK	<i>Yoshima</i>	PAGE	
	APPROVE	<i>R. Uno</i>	CODE NO.	353773
	SCALE		REG. TYPE	GX224 PWB353401A
	TOLERANCE		SECURITY LEVEL	CONFIDENTIAL
	DATE	1993.3.2		



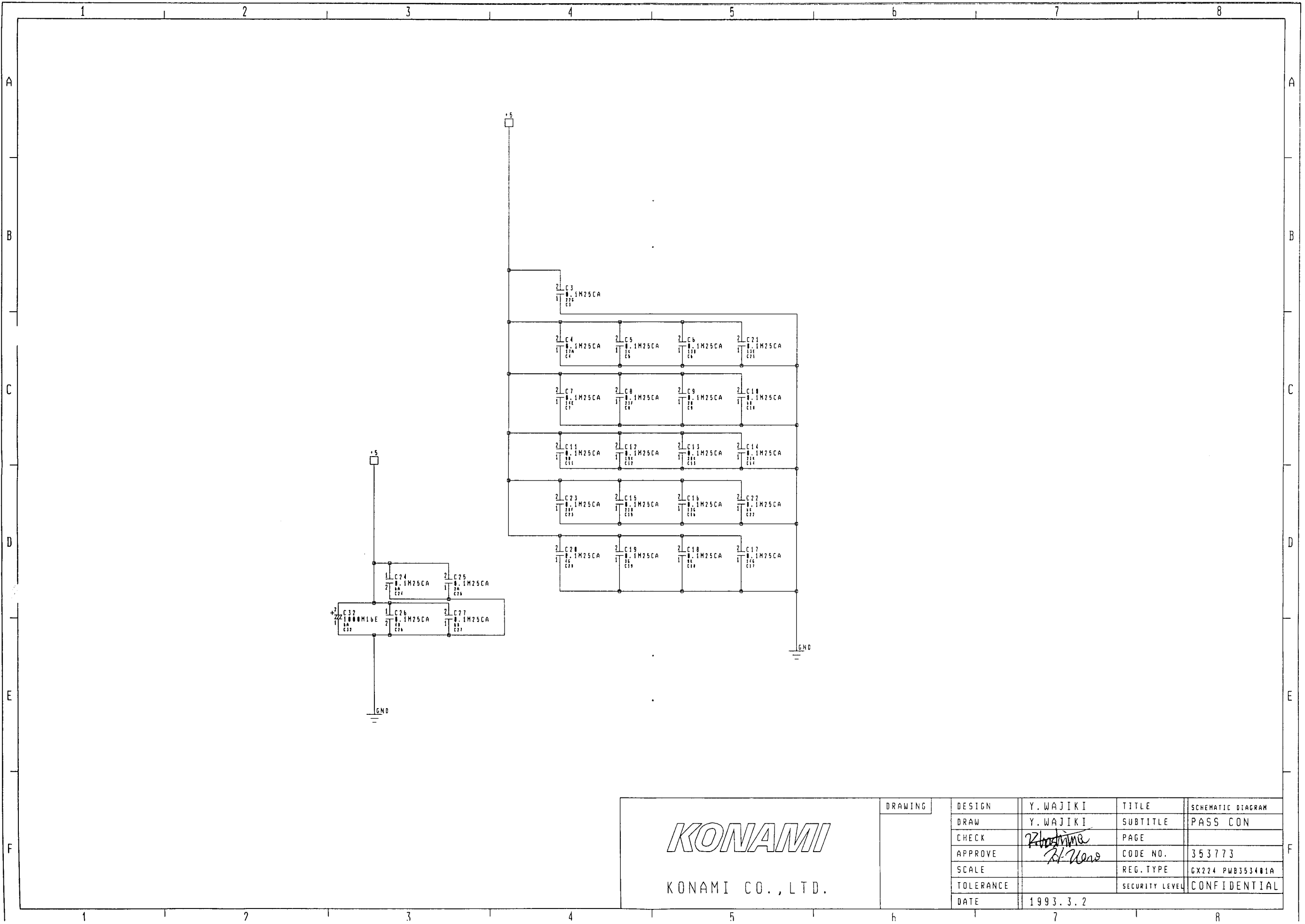

**KONAMI**

KONAMI CO., LTD.

DRAWING	DESIGN	Y. WAJIKI	TITLE	SCHEMATIC DIAGRAM
	DRAW	Y. WAJIKI	SUBTITLE	PASS CON
	CHECK	<i>[Signature]</i>	PAGE	
	APPROVE	<i>[Signature]</i>	CODE NO.	353773
	SCALE		REG. TYPE	GX224 PWB353401A
	TOLERANCE		SECURITY LEVEL	CONFIDENTIAL
DATE	1993.3.2			